

CREATIVE TENT SOLUTIONS

Industrial Pop-Up Tents & Umbrellas for Weather Protection



POP'N'WORK - GS4412

POP'N'WORK TENTS SET-UP IN SECONDS WITH NO LOOSE PARTS. EXCLUSIVE POP'N'WORK UNIFIED FRAME MADE WITH COLD ROLLED STEEL AND FIBERGLASS IS VIRTUALLY UNBREAKABLE.

FEATURES

- ◆ ONE DOOR TENT WITH AN 'A' SHAPE ZIPPER DOOR
- ◆ 7-1/2" X 16" VENT WINDOW IN THE BACK
- ◆ 10" BLOWER PORT IN THE BACK
- ◆ 12" GROUND FLAPS ON TWO SIDES
- ◆ 14' WINDLINES ON TWO SIDES
- ◆ QUICK-PACK STORAGE WRAP FOR EASY STORAGE
- ◆ WEIGHT: 28LBS
- ◆ BOXED DIMENSIONS: 58" x 8" x 8"

*Customization and additional features available

SPECIFICATIONS - 4' x 4' FOOTPRINT

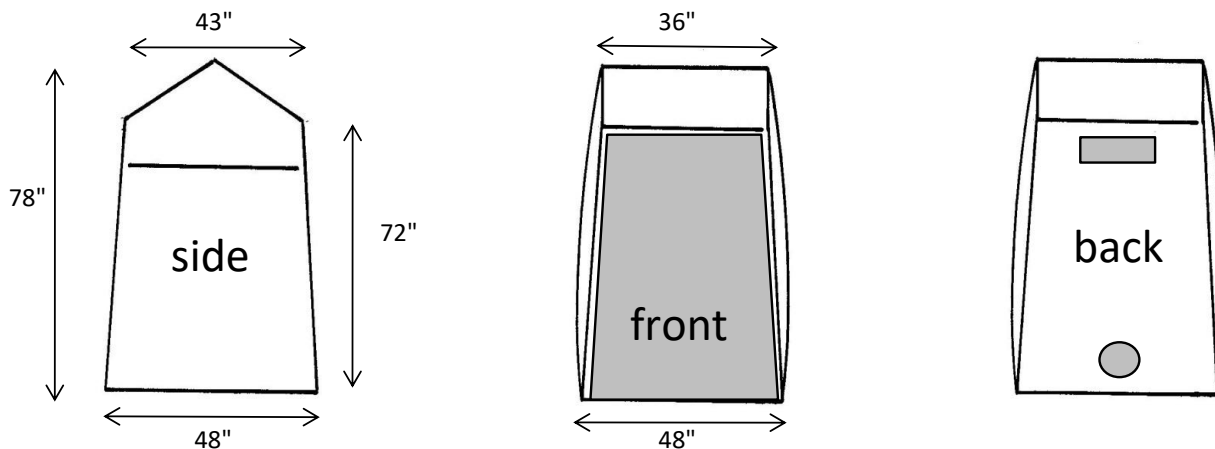

COVER

- ◆ SAFETY GREEN 300 DENIER COATED POLYESTER SIDEWALLS
- ◆ WHITE 250 DENIER COATED POLYESTER DOORS, BACK, AND ROOF
- ◆ URETHANE COATED POLYESTER
- ◆ FLAME RETARDANT - CPAI 84
- ◆ WATER REPELLENT AND UV TREATED

FRAME

- ◆ 18 GAUGE GALVANIZED TUBING FOR ROOF AND GROUND STRUTS
- ◆ COLD ROLLED STEEL HINGES
- ◆ 70% GLASS CONTENT FIBERGLASS ROD TENSION FRAME
- ◆ PITCHED ROOF